

## Silicon Field Stop(FS) Planar IGBT

### Description

The THG40N120FQKH is use advanced field stop(FS) technology.

The 1200V FS IGBT offers superior conduction and switching performances.

### General Features

- 1200V Breakdown Voltage
- Low saturation voltage: $V_{CE(sat)}$ ,typ=2.3V@ $I_C=40A$
- FS Planar Technology,Positive temperature coefficient
- High speed switch & Low power loss

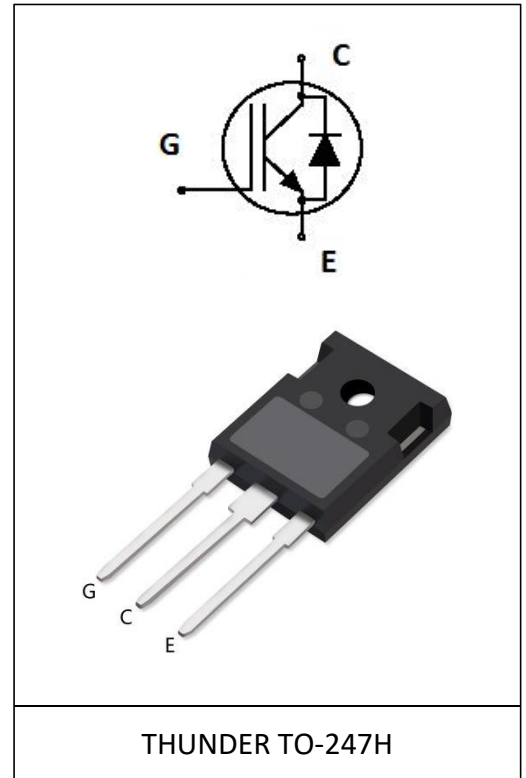

### Application

- Solar Converters
- Welding Converters
- UPS

### Product Summary

$V_{CE}$	1200V
$V_{CE(sat)}$	2.3V
$I_C$	40A

### MAXIMUM RATINGS ( $T_J = 25^\circ C$ unless otherwise noted)

Parameter		Symbol	Value	Unit
Collector-to-Emitter Voltage		$V_{CE}$	1200	V
Gate-to-Emitter Voltage		$V_{GE}$	$\pm 30$	V
Collector Current	$T_C=25^\circ C$	$I_C$	80	A
	$T_C=100^\circ C$		40	
Power Dissipation	$T_C=25^\circ C$	$P_D$	625	W
	$T_C=100^\circ C$		326	

Pulsed Collector Current	$T_C=25^{\circ}\text{C}$ $t_p=10\mu\text{s}$ (Note 1)	$I_{CM}$	120	A
Diode Forward Current	$T_C=25^{\circ}\text{C}$	$I_F$	80	
	$T_C=100^{\circ}\text{C}$		40	
Pulsed Diode Forward Current	$T_C=25^{\circ}\text{C}$ $t_p=10\mu\text{s}$ (Note 1)	$I_{FM}$	120	
Short Circuit Withstand Time $V_{GE} = 15\text{ V}, V_{CC} = 800\text{ V}, T_C = 150^{\circ}\text{C}$		$T_{SC}$	10	$\mu\text{s}$
Operating Junction and Storage Temperature Range		$T_J, T_{stg}$	-55 $T_o$ +175	$^{\circ}\text{C}$
Lead Temperature for Soldering Purposes		$T_L$	270	

### THERMAL CHARACTERISTICS

Parameter	Symbol	Value	Unit
Thermal Resistance, Junction-to-Case for IGBT	$R_{thJC}$	0.23	$^{\circ}\text{C}/\text{W}$
Thermal Resistance, Junction-to-Ambient	$R_{thJA}$	62.5	

### ELECTRICAL CHARACTERISTICS ( $T_J = 25^{\circ}\text{C}$ unless otherwise specified)

Parameter	Symbol	Value			Unit	Test Condition
		min.	typ.	max.		

#### OFF CHARACTERISTICS

Collector-to-Emitter Breakdown Voltage	$BV_{CES}$	1200	-	-	V	$V_{GE}=0\text{ V}, I_C=1\text{ mA}$
Zero Gate Voltage Collector Current	$I_{CES}$	-	-	40	$\mu\text{A}$	$V_{GE}=0\text{ V}, V_{CE}=V_{CES}$
Gate-to-Emitter leakage Current	$I_{GES}$	-	-	$\pm 400$	nA	$V_{GE}=\pm 30\text{ V}, V_{CE}=0\text{ V}$

#### ON CHARACTERISTICS

Gate-to-Emitter Threshold Voltage	$V_{GE(th)}$	4.8	-	6.6	V	$V_{GE}=V_{CE}, I_C=1\text{ mA}, T_J=25^{\circ}\text{C}$
Collector-to-Emitter Saturation Voltage	$V_{CE(sat)}$	-	2.3	2.8	V	$V_{GE}=15\text{ V}, I_C=40\text{ A}, T_J=25^{\circ}\text{C}$

**DYNAMIC CHARACTERISTICS**

Input Capacitance	$C_{IES}$	-	3262	-	pF	$V_{CE} = 25\text{ V}, V_{GE} = 0\text{ V},$ $f = 1\text{ MHz}$
Output Capacitance	$C_{OES}$	-	249	-		
Reverse Transfer Capacitance	$C_{RES}$	-	67	-		
Total Gate Charge	$Q_G$	-	220	-	nC	$V_{CE} = 600\text{ V}, V_{GE} = 15\text{ V},$ $I_C = 40\text{ A}$

**SWITCHING CHARACTERISTICS**

Turn-On Delay Time	$t_{d(on)}$	-	128	-	ns	$V_{CE} = 600\text{ V}$ $V_{GE} = 0/15\text{ V}$ $I_C = 40\text{ A}$ $R_G = 30\ \Omega$ $T_J = 25^\circ\text{C}$
Turn-Off Delay Time	$t_{d(off)}$	-	233	-		
Rise time	$t_r$	-	35	-		
Fall time	$t_f$	-	190	-		
Turn-On Switching Loss	$E_{on}$	-	5.9	-	mJ	
Turn-Off Switching Loss	$E_{off}$	-	1.4	-		
Total Switching Loss	$E_{ts}$	-	7.3	-		

**ELECTRICAL CHARACTERISTICS** ( $T_J = 25^\circ\text{C}$  unless otherwise specified) (continued)

Parameter	Symbol	Value			Unit	Test Condition
		min.	typ.	max.		

**SWITCHING CHARACTERISTICS**
**DIODE CHARACTERISTICS**

Diode Forward Voltage	$V_F$	-	2.2	3.3	-	$I_F = 40\text{ A}, T_J = 25^\circ\text{C}$
-----------------------	-------	---	-----	-----	---	---

**DIODE SWITCHING CHARACTERISTICS, INDUCTIVE LOAD**

Reverse Recovery Time	$t_{rr}$	-	39	-	ns	$V_R = 600\text{ V}, I_F = 40\text{ A},$ $dI_F/dt = 200\text{ A}/\mu\text{s}$ $T_J = 25^\circ\text{C}$
Reverse Recovery Charge	$Q_{rr}$	-	6920	-	nC	
Reverse Recovery Energy	$E_{rec}$	-	0.07	-	mJ	
Peak Reverse Recovery Current	$I_{RRM}$	-	28	-	A	

### Typical Performance Characteristics

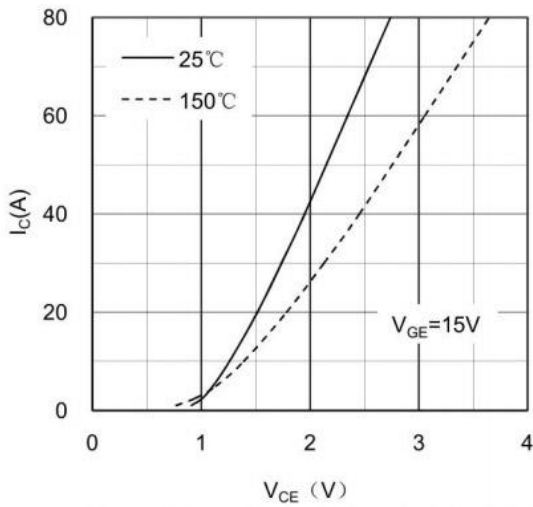

Figure 1. Typical Output Characteristics IGBT

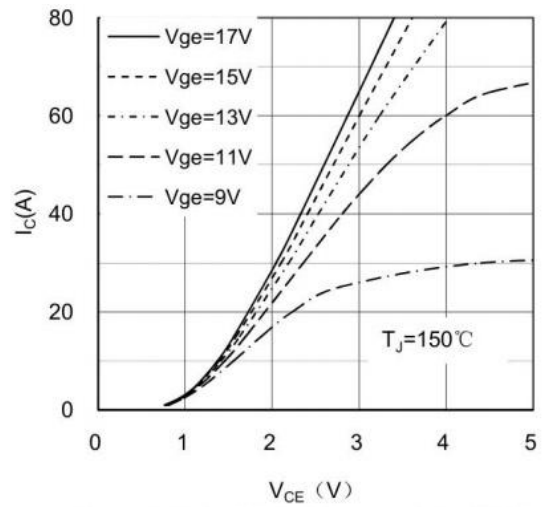

Figure 2. Typical Output Characteristics IGBT

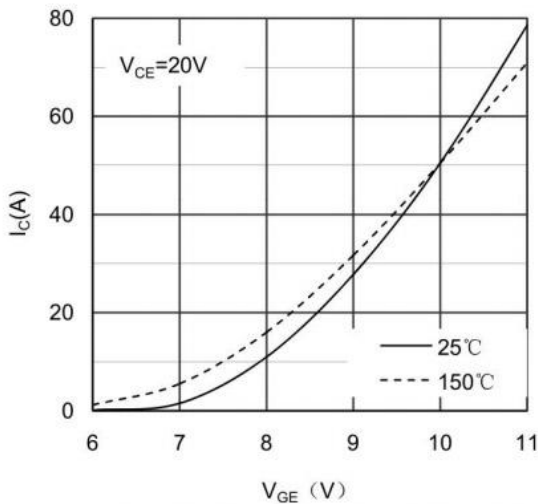

Figure 3. Typical Transfer characteristics IGBT

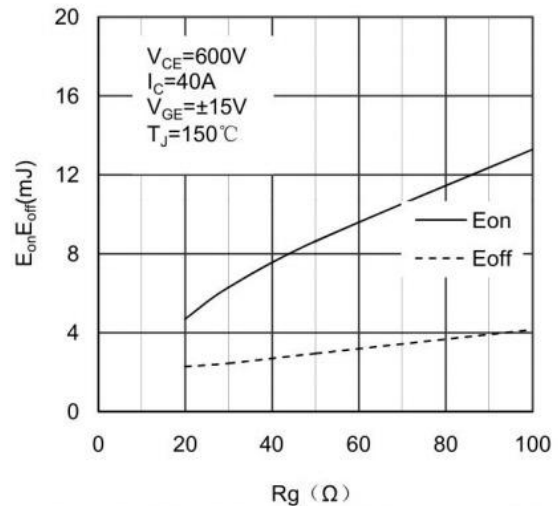

Figure 4. Switching Energy vs Gate Resistor IGBT

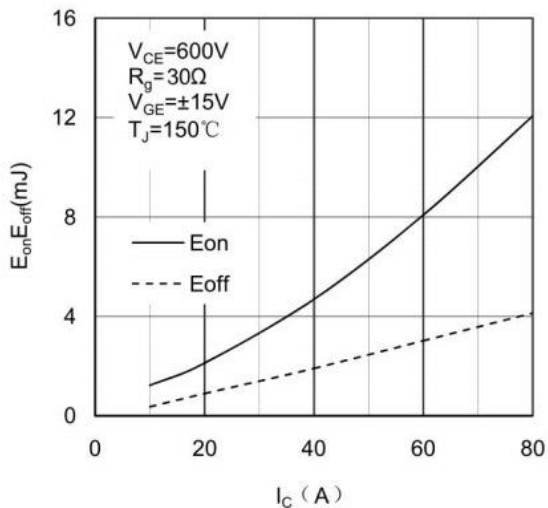

Figure 5. Switching Energy vs Collector Current IGBT

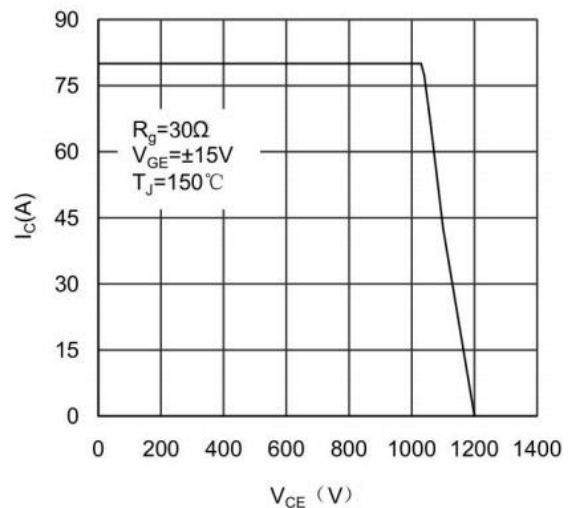

Figure 6. Reverse Biased Safe Operating Area IGBT

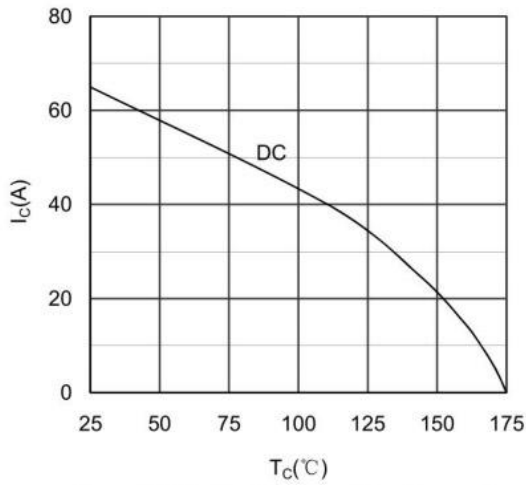

Figure 7. Collector Current vs Case temperature IGBT

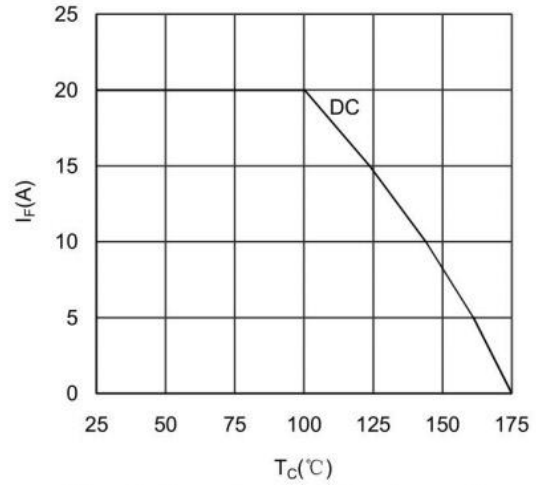

Figure 8. Forward current vs Case temperature Diode

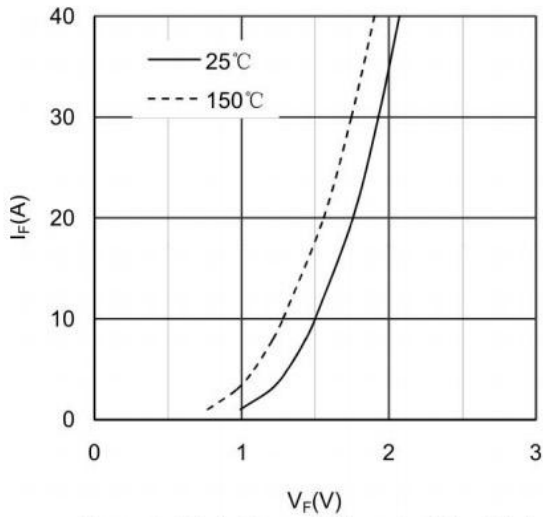

Figure 9. Diode Forward Characteristics Diode

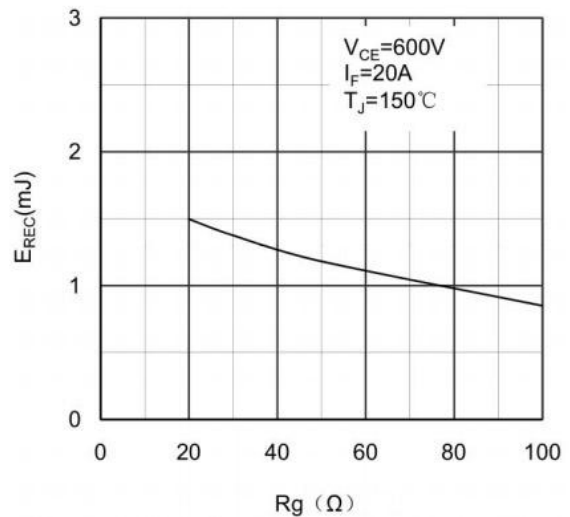

Figure 10. Switching Energy vs Gate Resistor Diode

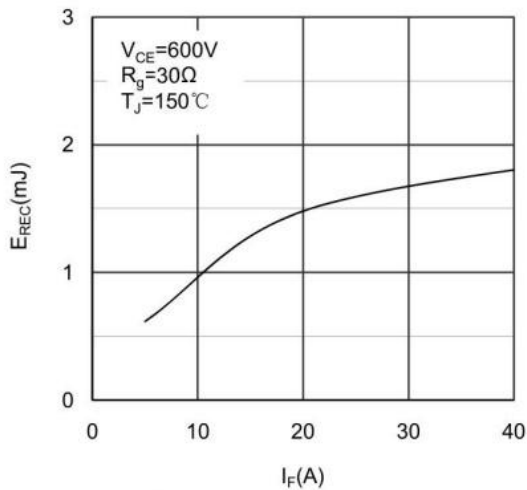

Figure 11. Switching Energy vs Forward Current Diode

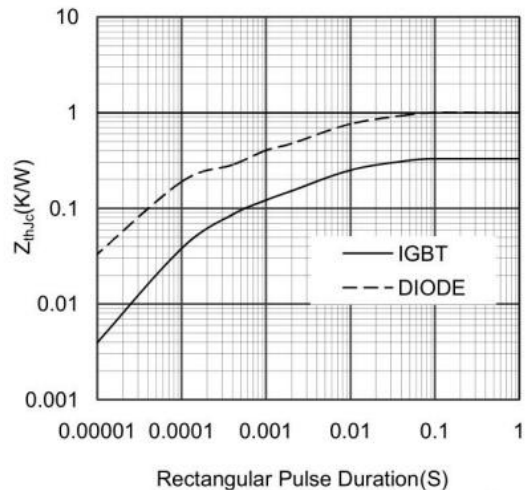
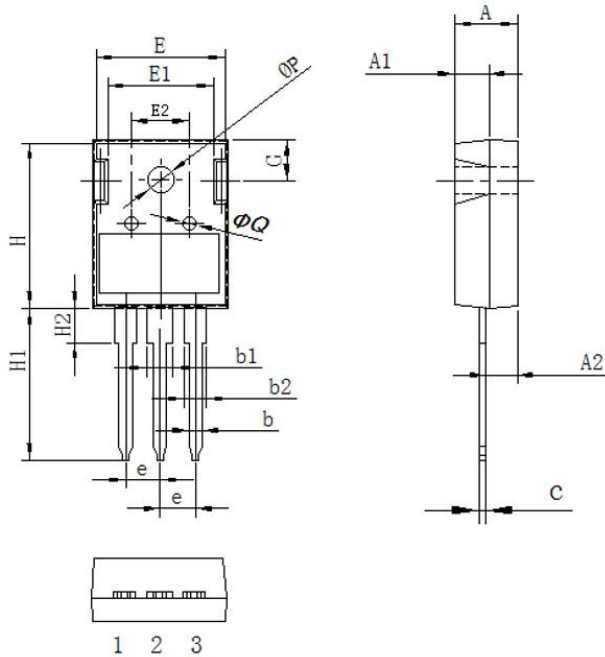

Figure 12. Transient Thermal Impedance of Diode and IGBT

## Package Information

### TO-247H PACKAGE

#### 基本尺寸



Symbol	单位 mm		
	Min	Nom	Max
A	4.80	5.00	5.20
A1	2.80	3.00	3.20
A2	2.20	2.40	2.60
b	1.05	1.20	1.35
b1	2.80	3.00	3.20
b2	1.80	2.00	2.20
c	0.50	0.60	0.70
e	5.35	5.45	5.75
E	15.6	15.80	16.0
E1	12.3	12.50	12.7
E2	6.00	6.20	6.40
H	20.5	21.0	21.5
H1	19.0	20.0	21.0
H2	3.00	4.00	5.00
G	5.70	5.90	6.10
$\Phi P$	3.30	3.50	3.50
$\Phi Q$	2.30	2.50	2.70

## Notice

Thunder Microelectronics Incorporated Limited reserves the right to make changes without further notice to any products or specifications herein. When use the product, be sure to obtain the latest specification.

Thunder Microelectronics Incorporated Limited does not assume any liability arising out of the application or any product described herein. When using Thunder Microelectronics Incorporated Limited products in your equipment, you are requested to take adequate safety measures to prevent the equipment from causing a physical injury ,fire or other problem if any of the products become faulty.

### -Headquarters

WuXi Thunder Microelectronics Incorporated Limited  
 Building E1-901, No.200 LingHu Road, XinWu district,WuXi,China 214135  
 Tel:+86-510-85160109 Fax:+86-510-85160109